



GrAndvance Technology  
SPECIFICATION FOR APPROVAL

CUSTOMER. STD

DESCRIPTION. DC AXIAL FAN

MODEL PART NO. AB0602512A-H-P0 REV. 00

CUSTOMER PART NO. \_ REV. \_

ISSUE DATE. DEC.10 2024

PLEASE SEND ONE COPY OF THIS SPECIFICATION BACK  
AFTER YOU SIGNED APPROVAL FOR PRODUCTION PRE-  
ARRANGEMENT.

APPROVED BY:

DATE :

GrAndvance Technology, Inc.  
6F.,No. 902, Jingguo Rd., Luzhu Dist.,  
Taoyuan City 338, Taiwan, R.O.C.

客戶料號(CUSTOMER PART NO): \_

機種料號(MODEL PART NO): AB0602512A-H-P0

## 1. 範圍(SCOPE):

此規格定義了直流風扇的電氣與機械特性，此風扇採用單相或三相馬達驅動設計。

THIS SPECIFICATION DEFINES THE ELECTRICAL AND MECHANICAL CHARACTERISTICS OF THE DC FAN. THE FAN MOTOR IS WITH SINGLE-PHASE OR THREE-PHASE DESIGN.

## 2. 特性(CHARACTERISTICS):

ITEM	DESCRIPTION
額定電壓(RATED VOLTAGE)	12 VDC
操作電壓(OPERATION VOLTAGE)	7.0-13.2 VDC
輸入電流(INPUT CURRENT)	0.70 (MAX. 0.91 ) A SAFETY CURRENT: 1.05 A
輸入功率(INPUT POWER)	8.40 (MAX. 10.92 ) W
風扇轉速(SPEED)	10000 ± 10 % R.P.M.
最大風量(MAX. AIR FLOW) (AT ZERO STATIC PRESSURE)	46.92 (MIN. 42.23 ) CFM 1.328 (MIN. 1.195 ) M <sup>3</sup> /MIN.
最大風壓(MAX.AIR PRESSURE) (AT ZERO AIRFLOW)	24.87 (MIN. 20.14 ) mmH <sub>2</sub> O 0.979 (MIN. 0.793 ) inchH <sub>2</sub> O
噪音(ACOUSTICAL NOISE) (AVG.)	53.0 (MAX. 57.0 ) dB-A
絕緣類型(INSULATION TYPE)	UL: CLASS A
絕緣阻抗(INSULATION STRENGTH)	在扇框和導線正極之間通直流500V，絕緣電阻 不小於10MEGA OHM 10 MEGA OHM MIN. AT 500 VDC (BETWEEN FRAME AND (+) TERMINAL)
絕緣強度(DIELECTRIC STRENGTH)	在扇框和導線正極之間通交流電500V， 50/60Hz，持續一分鐘，測試結果不大於5mA 5 mA MAX. AT 500 VAC 50/60 Hz ONE MINUTE, (BETWEEN FRAME AND (+) TERMINAL)
風扇壽命(LIFE EXPECTANCE) (L10)	可連續運轉 70000 小時 (環境溫度 40 °C、濕度 65 %RH) 70000 HOURS CONTINUOUS OPERATION AT 40°C WITH 65 %RH.
風扇轉向(ROTATION)	從標籤面看為順時針轉向 CLOCKWISE DIRECTION FROM LABEL SIDE

-----  
客戶料號(CUSTOMER PART NO): \_  
-----

機種料號(MODEL PART NO): AB0602512A-H-P0  
-----

說明(NOTES):

- 1.所有計數都要在穩定升溫3分鐘後測量  
ALL READINGS ARE MEASURED AFTER STABLY WARMING UP THROUGH 3 MINUTES.
- 2.標準測試條件是在25°C · 65%相對溼度 · 760mmHg 大氣壓下測量.  
STANDARD AIR PROPERTY IS AIR AT (Td) 25°C TEMPERATURE, (RH) 65% RELATIVE HUMIDITY, AND (Pb) 760 mmHg BAROMETRIC PRESSURE.
- 3.噪音測試條件如下:  
ACOUSTICAL NOISE MEASURING CONDITION:

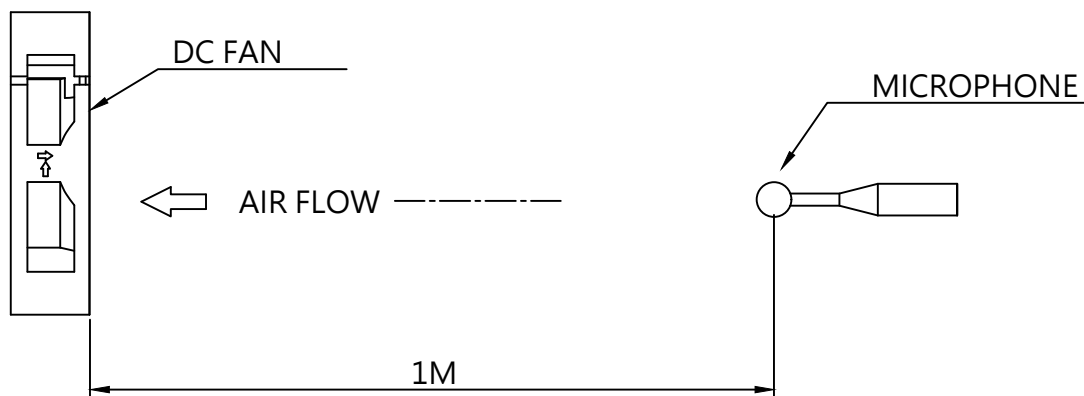

噪音測試是在半消音室中，風扇處於自由空氣中，在額定電壓下，進風面距離麥克風一定距離進行測試

NOISE IS MEASURED AT RATED VOLTAGE IN FREE AIR IN ANECHOIC CHAMBER WITH B & K SOUND LEVEL METER WITH MICROPHONE AT A PARTICULAR DISTANCE FROM THE FAN INTAKE.

3. 結構系統(MECHANICAL):

- |                              |       |                                |
|------------------------------|-------|--------------------------------|
| 3-1. 框架材質(FRAME MATERIAL)    | ----- | PLASTIC BLACK UL: 94V-0 (黑色塑膠) |
| 3-2. 葉輪材質(IMPELLER MATERIAL) | ----- | PLASTIC BLACK UL: 94V-0 (黑色塑膠) |
| 3-3. 軸承系統(BEARING SYSTEM)    | ----- | TWO BALL (滾珠軸承)                |
| 3-4. 重量 (WEIGHT)             | ----- | 70 GRAM. (REF)                 |

4. 環境(ENVIRONMENTAL):

- |                                  |       |               |
|----------------------------------|-------|---------------|
| 4-1. 工作溫度(OPERATING TEMPERATURE) | ----- | -10 TO +70 °C |
| 4-2. 儲存溫度(STORAGE TEMPERATURE)   | ----- | -40 TO +75 °C |
| 4-3. 工作濕度(OPERATING HUMIDITY)    | ----- | 5 TO 90 % RH  |
| 4-4. 儲存濕度(STORAGE HUMIDITY)      | ----- | 5 TO 95 % RH  |

-----  
客戶料號(CUSTOMER PART NO): \_  
-----

機種料號(MODEL PART NO): AB0602512A-H-P0  
-----

5. 保護功能(PROTECTION):

5-1. 堵轉保護(LOCKED ROTOR PROTECTION):

馬達繞組阻抗保護電機在額定電壓 72 小時鎖定轉子狀態下不受損害  
IMPEDANCE OF MOTOR WINDING PROTECTS MOTOR FROM FIRE IN 72  
HOURS OF LOCKED ROTOR CONDITION AT THE RATED VOLTAGE.

5-2. 極性保護(POLARITY PROTECTION):

能夠承受導線正極與負極的反向連接。  
BE CAPABLE OF WITHSTANDING IF REVERSE CONNECTION FOR POSITIVE  
AND NEGATIVE LEADS.

6. RE 消耗臭氧層物質(RE OZONE DEPLETING SUBSTANCES):

6-1. 不包含 PBBs, PBBOs, CFCs, PBBEs, PBDPEs 與 HCFCs 物質。  
NO CONTAINING PBBs, PBBOs, CFCs, PBBEs, PBDPEs AND HCFCs.

7. 生產地(PRODUCTION LOCATION):

7-1. 產品生產於中國  
PRODUCTS WILL BE PRODUCED IN CHINA.

客户料號(CUSTOMER PART NO): \_

機種料號(MODEL PART NO): AB0602512A-H-P0

8. 風扇P&Q曲線(P&Q CURVE):

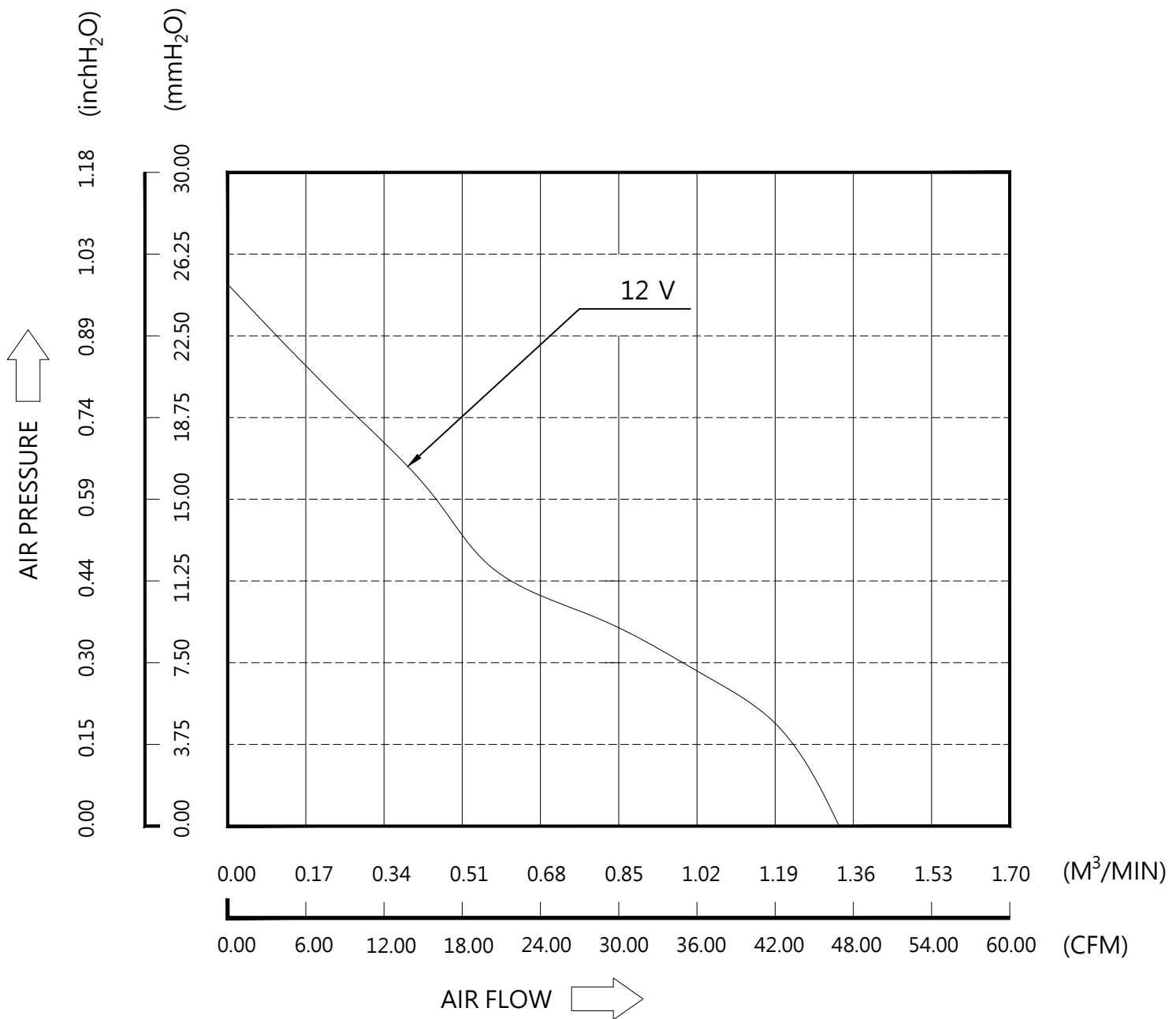

-----  
客戶料號(CUSTOMER PART NO): \_  
-----

機種料號(MODEL PART NO): AB0602512A-H-P0  
-----

9. 風扇尺寸圖(Dimension Drawing): UNIT: mm

標籤(LABEL):

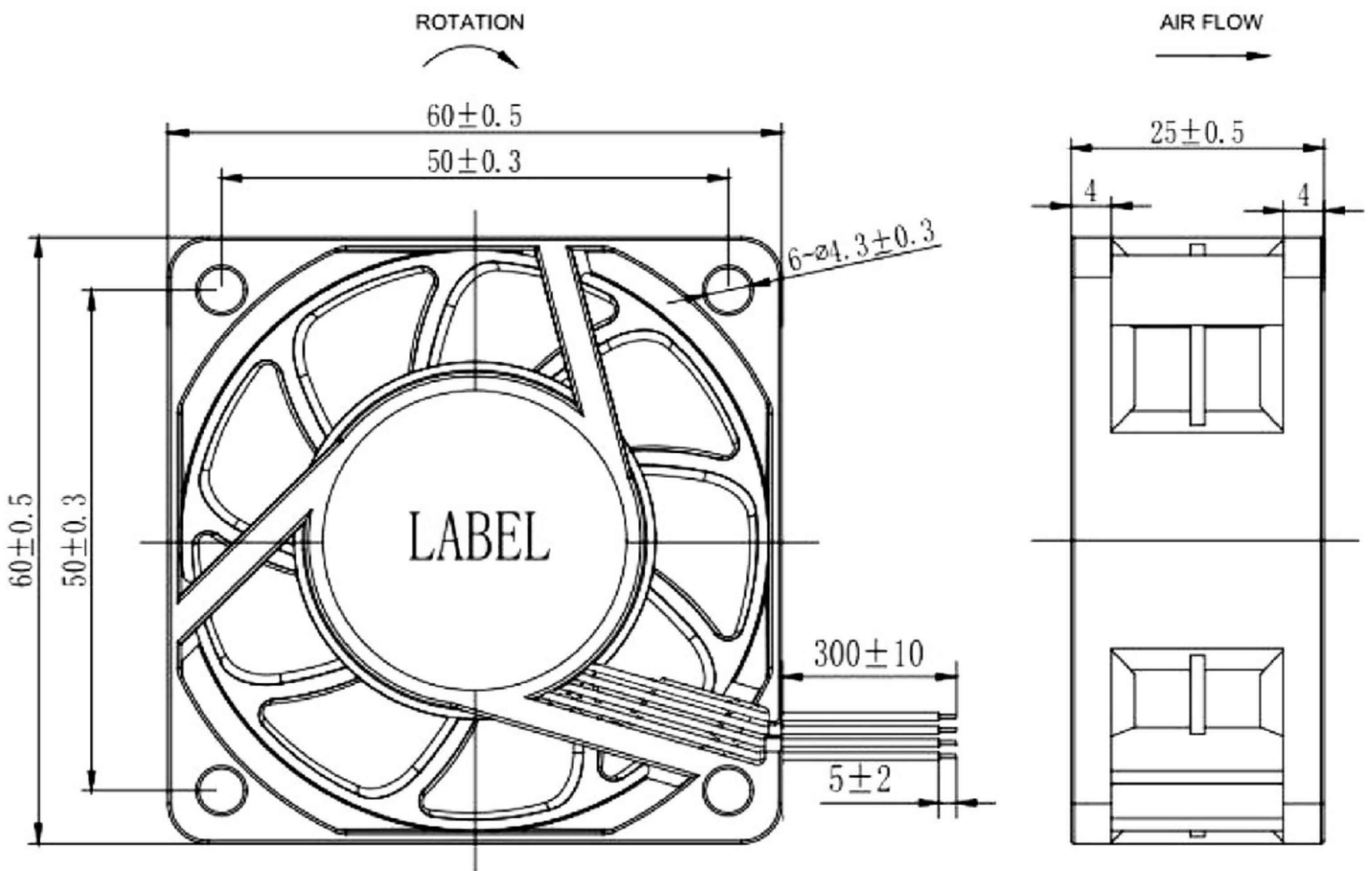

說明(NOTES):

1. 外殼型號 HOUSING: N/A
2. 端子型號 TERMINAL: N/A
3. 線材型號 CABLE WIRE : UL 10368 #26

PIN 1:	BLACK WIRE	----- (-)	黑色線
PIN 2:	RED WIRE	----- (+)	紅色線
PIN 3:	YELLOW WIRE	----- (FG)	黃色線
PIN 4:	BLUE WIRE	----- (PWM)	藍色線

-----  
客戶料號(CUSTOMER PART NO): \_  
-----

機種料號(MODEL PART NO): AB0602512A-H-P0  
-----

## 10. FG信號功能 (FG FUNCTION)

### 10-1. FG信號(FREQUENCY GENERATOR (FG) SIGNAL):

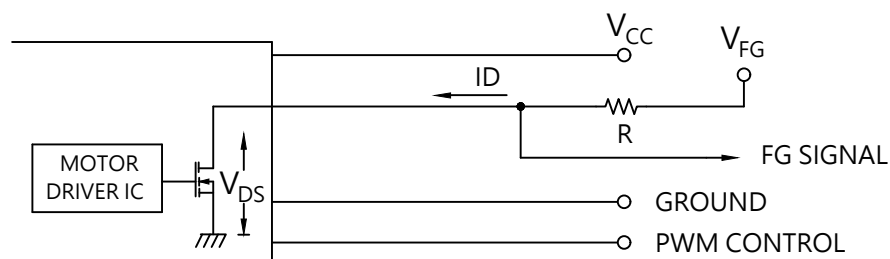

#### 警告(CAUTION):

FG 信號線不可與正負極線短路

THE FG SIGNAL LEAD WIRE MUST BE KEPT AWAY FROM  
"+" LEAD WIRE & "-" LEAD WIRE.

### 10-2. 信號規範(SPECIFICATION):

$V_{FG} = DC \ 12V \ TYP. (V_{CC} \ MAX.)$

$I_D = 5mA \ MAX. \quad R \geq V_{FG} / I_D$

電阻不包含風扇電路且必須由使用者提供

THE RESISTOR R IS NOT INCLUDED IN FAN CIRCUIT AND NEEDS TO  
BE PROVIDED BY FAN USER.

### 10-3. 頻率生成波型(FREQUENCY GENERATOR WAVEFORM):

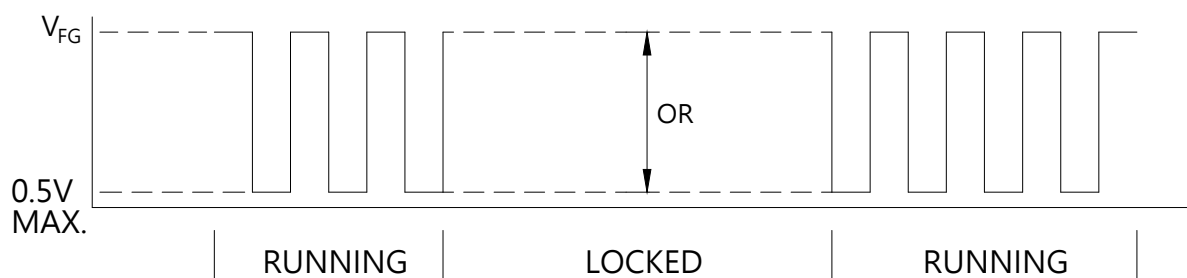

風扇運轉極數波型 (POLES WAVE WHEN FAN RUNNING)

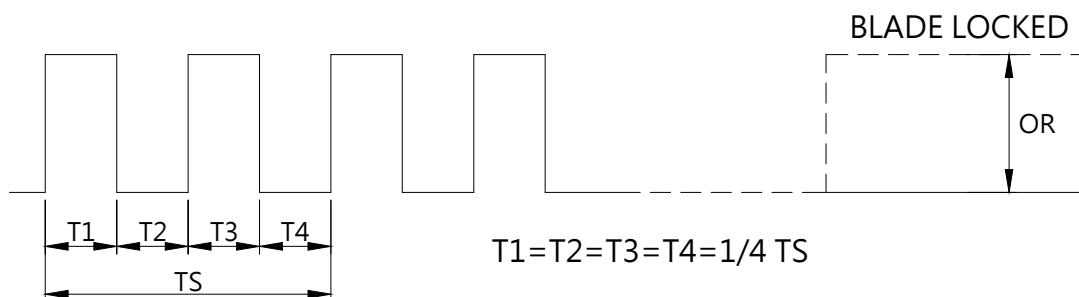

$$N(R.P.M) = \frac{1}{TS} * 60$$

-----  
客户料號(CUSTOMER PART NO): \_  
-----

機種料號(MODEL PART NO): AB0602512A-H-P0  
-----

## 11. PWM 控制功能 (PWM CONTROL FUNCTION)

### 11-1. PWM控制介面 (PWM CONTROL INTERFACE)

SIGNAL VOLTAGE RANGE: 0 ~ (V<sub>+</sub> - 0.5) VDC



- HIGH LEVEL : (V<sub>+</sub> - 0.5) VDC max.  
2.0 VDC min.
- LOW LEVEL : 0.8 VDC max.  
0 VDC min.
- R<sub>pu</sub> : 200Kohm ~ 500Kohm.

- R<sub>pu</sub> 是建立在驅動IC的半導體晶圓阻抗之初始值  
THE R<sub>pu</sub> IS A SEMICONDUCTOR RESISTOR BUILT IN THE IC WAFER OF THE FAN DRIVER FOR THE DEFAULT SETTING.
- PWM信號的控制頻率可設定為20KHz~50KHz，建議值為25KHz  
(THE FREQUENCY FOR CONTROL SIGNAL OF THE FAN SHALL BE ABLE TO ACCEPT A 20KHZ~50KHZ. AND THE PREFERRED OPERATING FREQUENCY OF PWM SIGNAL IS 25KHZ.)
- 100% DUTY下，轉子將以最大速度運轉  
(AT 100% DUTY CYCLE, THE ROTOR WILL SPIN AT MAXIMUM SPEED.)
- 0% DUTY下，轉子將停止運轉  
(AT 0% DUTY CYCLE, THE ROTOR WILL STOP TO SPIN.)
- 若PWM訊號線未連接，轉子將以最大速度運轉  
(WHEN THE PWM CONTROL LEAD WIRE IS DISCONNECTED, THE ROTOR WILL SPIN AT MAXIMUM SPEED.)

### 11-2. THE REQUIREMENT OF WAVEFORM QUALITY OF PWM SIGNAL

- 建議從系統輸出的PWM信號為TTL (t<sub>r</sub>=50ns, t<sub>f</sub>=50ns)，即使PWM線未連接也是如此  
THE RECOMMENDED PWM SIGNAL FROM SYSTEM IS TTL (t<sub>r</sub>=50ns, t<sub>f</sub>=50ns), EVEN IF THE PWM LEAD OF FAN IS DISCONNECTED.
- 允許最大的波形失真:  
(THE MAXIMUM PERMISSIBLE OF WAVEFORM DISTORTION):

$$V_{IH} : (V_+ - 0.5) 90\%$$

$$\text{RISE TIME: } t_r < 500\text{ns}$$

$$V_{IL} : (V_+ - 0.5) 10\%$$

$$\text{FALL TIME: } t_f < 500\text{ns}$$

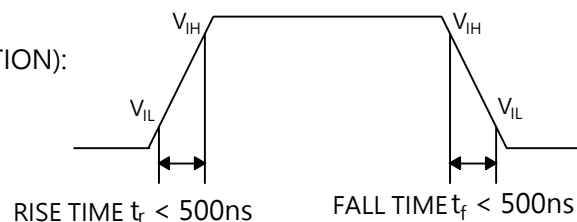

### 11-3. FAN CHARACTERISTICS (風扇特性)

TEST CONDITION(測試條件) : AT 25°C, V<sup>+</sup> = DC 12V & PWM SIGNAL AS FOLLOW

DUTY CYCLE (%)	SPEED (R.P.M.) (REF)	CURRENT (A) (REF)
100	10000 ± 10%	0.70
0	0	0.2(mA)

\* PWM SIGNAL

PWM FREQUENCY = 25 KHz

- 最低啟動DUTY CYCLE (MIN. STARTED DUTY CYCLE) : 30%  
WHEN DUTY CYCLE IS SET FOR MORE THAN 30% , THE FAN WILL BE ABLE TO START FROM A DEAD STOP.

-----  
客户料號(CUSTOMER PART NO): \_  
-----

機種料號(MODEL PART NO): AB0602512A-H-P0  
-----

## 12. 安全提示(SAFETY NOTICE):

1. In case of using bolt-nut fasteners, the flatness of chassis mating surfaces should be kept below 0.1 mm.
2. In case of using bolt-nut fasteners, this model was designed to be installed by fastening at either inlet or outlet flange only (Figure A). In cases of the bolt to be applied to the nut, the torque must not exceed:  
2.1 Flange type frame: 4.5 kgf-cm (Figure C)  
2.2 Rib type frame: 7.5 kgf-cm (Figure D)
3. In case of using self-tapping screws, appropriate screws according to JIS B 1122 Type 2 should be used. The dimensional details of the self-tapping screws recommended are shown in Table A. Each fastener hole should only be tightened once; repeated locking may cause sliding phenomenon. In addition, the torque to be applied to the self-tapping screws must not exceed the values stated in Table 1.
4. The countersunk part of the fastener head should not interfere with the frame, or there would be a risk of breakage (Figure E). Fastener heads with a flat inner surface, i.e., no countersink, are recommended.



TABLE(1)

MOUNTING HOLE DIAMETER	SCREW SPEC	MAJOR DIAMETER[FIG.(f)]		RECOMMENDED MAX.TORQUE	
		MAX.	MIN.	FLANGE TYPE FRAME	RIB TYPE FRAME
Φ3.5	M4.0x1.41	4.0	3.85	4.5	7.5
Φ4.3	M4.8x1.59	4.8	4.65	5.5	7.5
Φ4.5	M5.0x1.59	5.0	4.85	5.5	7.5

NOTE:

1. Reference standard JIS B 1122
2. A lower torque than the recommended value should be used if slippage is observed.

-----  
客户料號(CUSTOMER PART NO): \_  
-----

機種料號(MODEL PART NO): AB0602512A-H-P0  
-----

1. GRA will not guarantee the performance of the products if the application condition falls outside the parameters set forth in the specification.
2. A written request should be submitted to GRA prior to approval if deviation from this specification is required.
3. Please exercise caution when handling fans. Damage may be caused when pressure is applied to the impeller, if the fans are handled by the lead wires, or if the fan was hard-dropped to the production floor.
4. Except as pertains to some special designs, there is no guarantee that the products will be free from any such safety problems or failures as caused by the introduction of powder, droplets of water encroachment of insect into the hub.
5. The above-mentioned conditions are representative of some unique examples and viewed as the first point of reference prior to all other information.
6. It is very important to establish the correct polarity before connecting the fan to the power source. Positive (+) and Negative (-). Damage may be caused to the fans if connection is with reverse polarity, if there is no foolproof method to protect against such error specifically mentioned in this spec.
7. GRA fans without special protection are not suitable where any corrosive fluids are introduced to their environment.
8. Please ensure all fans are stored according to the storage temperature limits specified. Do not store fans in a high humidity environment. We highly recommend performance testing is conducted before shipping, if the fans have been stored over 6 months.
9. Not all fans are provided with the Lock Rotor Protection feature. If you impair the rotation of the impeller for the fans that do not have this function, the performance of those fans will lead to failure.
10. Please be cautious when mounting the fan. Incorrect mounting of fans may cause excess resonance, vibration and subsequent noise.
11. It is important to consider safety when testing the fans. A suitable fan guard should be fitted to the fan to guard against any potential for personal injury.
12. Except where specifically stated, all tests are carried out at room (ambient) temperature and relative humidity conditions of 25oC, 65% RH. The test value is only for fan performance itself.
13. Be certain to connect an “ 4.7μF or greater” capacitor to the fan externally when the application calls for using multiple fans in parallel, to avoid any unstable power.